

ALUMINUM MODULAR RAMP & STAIR SYSTEM CONFIGURATION OPTIONS

TYPICAL COMPONENT SIZES

- LANDINGS: PLATFORM UNITS CAN BE BOLTED TOGETHER FOR LARGER PLATFORMS
  - RAMP: 48" WIDE UNITS CAN BE BOLTED TOGETHER TO FORM A MAXIMUM 30' RAMP RUN
  - STAIRS: MAX. 6"-7" RISE X 12" TREAD X 48" WIDE
- NOTE: WHERE DOOR CLEARANCE ALLOWS, STAIRS CAN BE ADDED TO ANY/ALL OF THE CONFIGURATIONS SHOWN BELOW.

A TYPICAL SINGLE DOOR CONFIGURATION

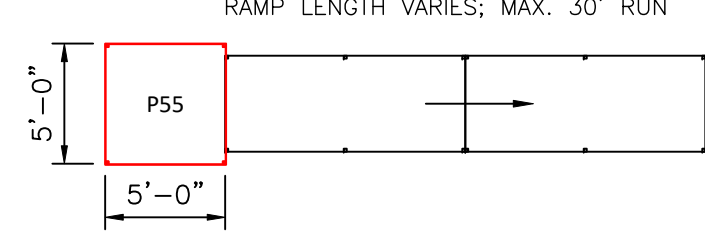

B TYPICAL SINGLE DOOR CONFIGURATION

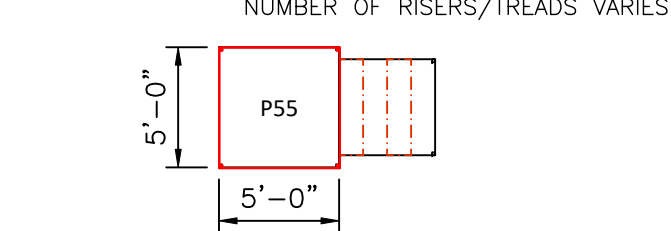

C TYPICAL DOUBLE DOOR CONFIGURATION

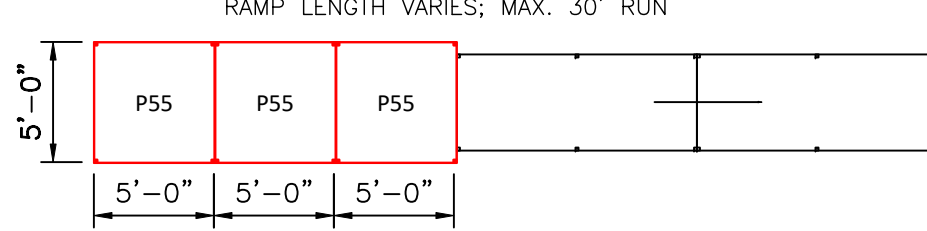

D TYPICAL TWO-BUILDING COMMON LANDING CONFIGURATION

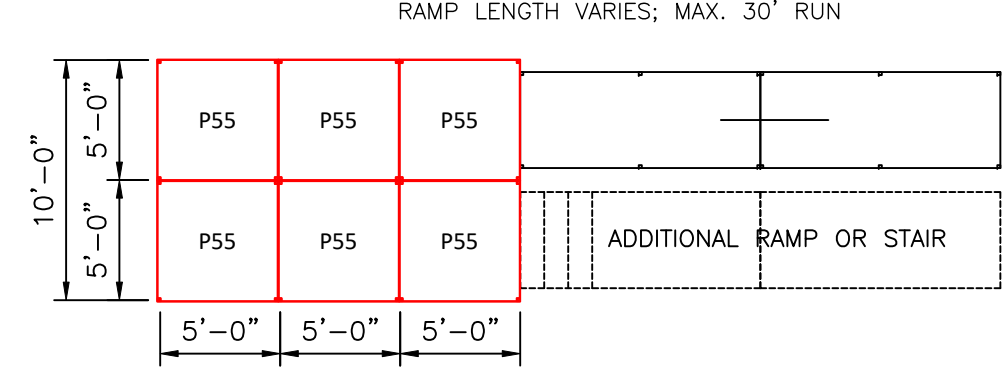

E TYPICAL INTERMEDIATE LANDING CONFIGURATION

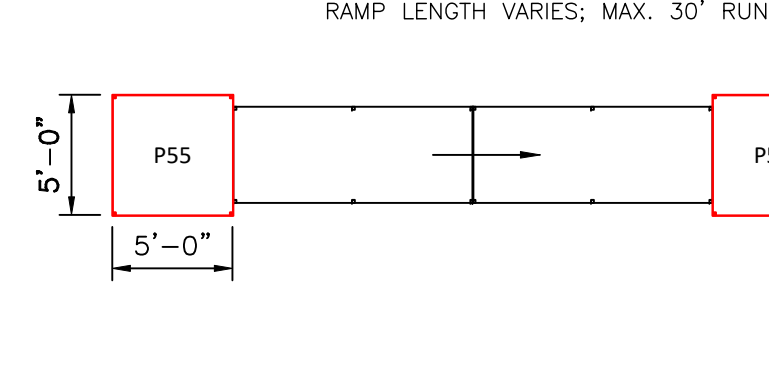

F TYPICAL SWITCHBACK CONFIGURATION

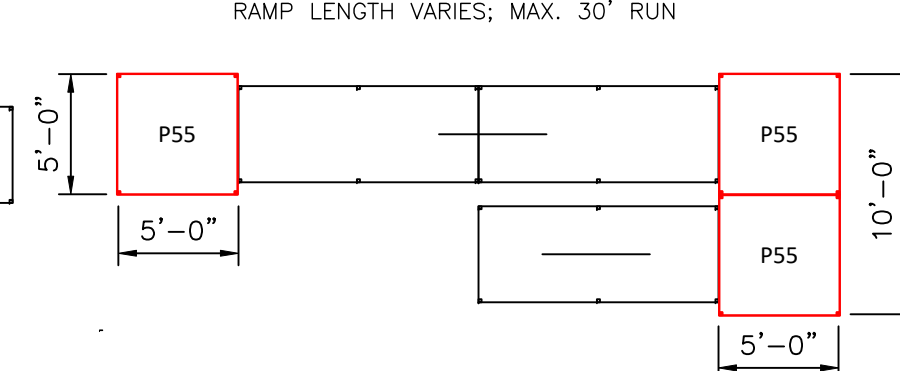

G DOUBLE DOOR EXIT 1/8" = 1'-0"

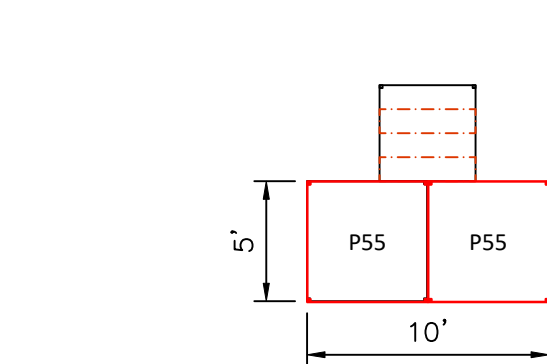

H ALTERNATE DOUBLE DOOR EXIT 1/8" = 1'-0"

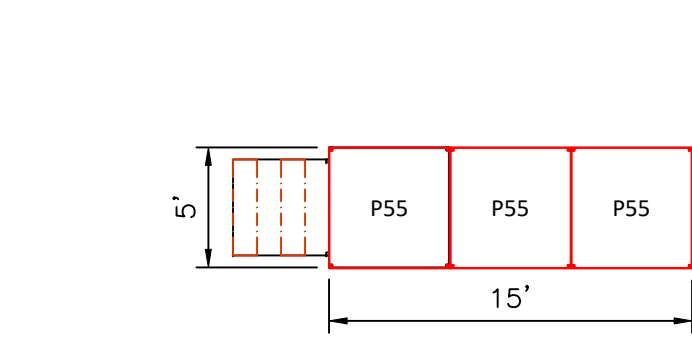

I DUMPSTER RAMP 1/8" = 1'-0"

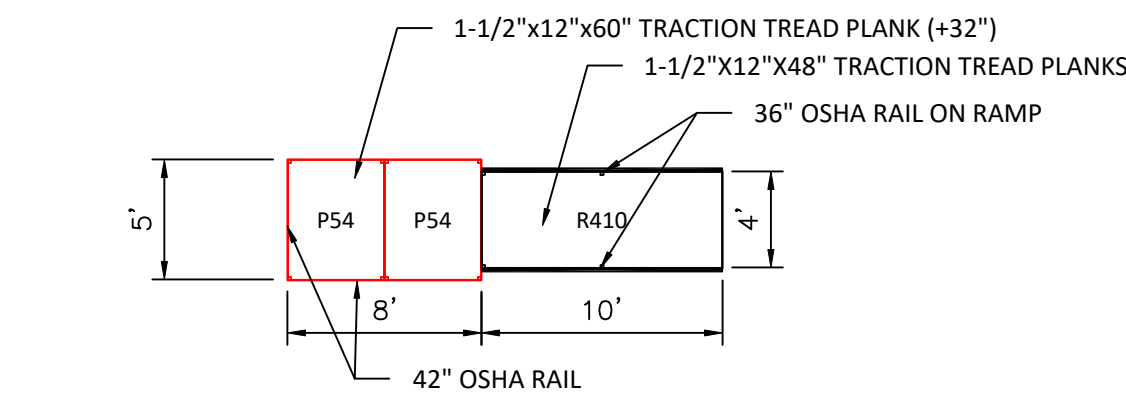

J CUSTOM CONFIGURATION

1/8" = 1'-0"

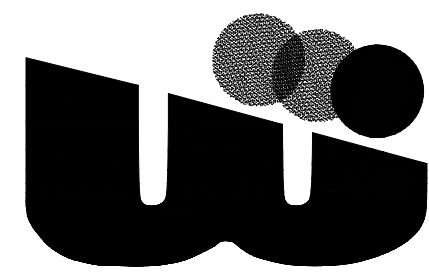

**Welcome Ramp Systems, Inc.**  
 Component Aluminum Ramp System for  
 Safe, User-Friendly Building Access.  
[www.welcomerampsystems.com](http://www.welcomerampsystems.com)

CODE COMPLIANCE

- IBC 2015, CHAPTER 10 COMPLIANT
- ANSI A117.1-2009 COMPLIANT
- RAMP SLOPE, MAX. RISE = 1:12 (VERT/HORZ)
- CROSS SLOPE, MAX. = 2%
- STAIR RISE = 7" MAX., 4" MIN.
- DESIGN LOADING:
  - 6.1. DECK/RAMP 100 PSF
  - 6.2. STAIR TREAD 300 LBS./TREAD
  - 6.3. RAILING 50 PLF/200 LBS. CONC.
  - 6.4. LATERAL LOAD 600# PEDESTRIAN DYNAMIC LOADING PER 30'-FT RAMP
  - 6.5. WIND LOAD 135 MPH, EXP C, Kzt=2.0
  - 6.6. SEISMIC LOAD Sds=1.0, SEISMIC CAT. 'D'
- DOOR CLEARANCE AS REQUIRED BY IBC.
- STANDARD 3 LINE RAIL FOR COMPONENTS 30" OR LESS FROM GRADE TO WALKING SURFACE OF RAMP, LANDING, OR STAIR.
- 42" VERTICAL PICKET GUARDRAIL FOR COMPONENTS OVER 30" FROM GRADE TO WALKING SURFACE OF RAMP, LANDING, OR STAIR.
- GRASPABLE CONTINUOUS HANDRAIL AT 36" OFF RAMP, PLATFORM, OR STAIR NOSING. INSTALL BOTH SIDES OF STAIRS AND RAMP.
- HANDRAILS TO EXTEND 12" HORIZONTALLY OVER WALKING SURFACE AND RETURN TO WALL OR RAIL COLUMN.
- RAMP AND RAILINGS TO HAVE CURBS WHICH DO NOT ALLOW PASSAGE OF 4" SPHERE WHERE ORIGINAL POSITION OF SPHERE IS WITHIN 4" OF THE WALKING SURFACE.
- FOOTING INFORMATION:
  - 12"x12"x1-1/2" P-I, WOOD OR 12"x12" PRE-MANUFACTURED ABS PAD REQUIRED UNDER ALL ADJUSTABLE LEGS.

GENERAL NOTES:

- THESE PLANS AND SPECIFICATIONS ARE NOT VALID FOR ANY OTHER ASSEMBLY THAN PRODUCTS PRODUCED BY WELCOME RAMP SYSTEMS, INC. PRODUCTS PRODUCED BY OTHER MANUFACTURERS HAVE BEEN DESIGNED TO MEET IBC REQUIREMENTS. THE VERTICAL DESIGN LOADING CRITERIA IS 100 PSF UNIFORM LIVE LOAD AND 300# LIVE OR DEAD CONCENTRATED LOAD. USES FOR LOADS IN EXCESS OF THOSE STATED ABOVE REQUIRE REDESIGN BY WELCOME RAMP SYSTEMS, INC.
  - RAMP DESIGN LIMITS: THE SLOPE SHALL BE 1:12; THE MAXIMUM CROSS SLOPE SHALL BE LESS THAN 2%. THE MAXIMUM RUN SHALL BE 30'. THE MAXIMUM HEIGHT WITHOUT ADDITIONAL ENGINEERING JUSTIFICATION SHALL BE 48" FROM THE PLATFORM TO FINISHED GRADE.
  - WELCOME RAMP SYSTEMS, INC. PLATFORMS, AND STAIRS ARE DESIGNED TO BE FREE STANDING. DETAILS SHOW MOST USED HEIGHTS, OTHER HEIGHTS ARE SIMILAR.
- MATERIAL SPECIFICATIONS**
- PLANKING:**
- THIS DESIGN IS LIMITED TO GALVANIZED METAL PLANKING MATERIALS.
  - RAMP: ALL PLANKING SHALL BE 13 GA. 12" W x 1 1/2" DEEP.
  - PLATFORM: ALL PLANKING SHALL BE 13 GA. 12" W x 1 1/2" D. SEE PLAN FOR LENGTH.
  - STAIRS: ALL PLANKING SHALL BE 11 GA. 12" W x 2" DEEP.
- LEGS:**
- LEVELING FEET ASSUMED TO BE PLACED ON SUITABLE FIRM BEARING GROUND.
  - LEG MATERIAL SHALL BE 1-1/2" SQ. X .125" AL TUBING.
  - LEG POCKETS SHALL BE 1.781" SQ. X .125" AL TUBING.
  - ADJUSTING BOLT - 3/8" X 2-1/4" GRADE 5 CAP SCREW W/NYLON LOCK NUT, ZINC PLATED
- ALUMINUM:**
- 1-1/2" AL HANDRAIL SHALL BE 6063-T5 WITH A YIELD STRESS OF 16 KSI.
  - ALL OTHER ALUMINUM PARTS SHALL BE 6061-T6 ALUMINUM WITH A YIELD STRESS OF 35 KSI.
- HANDRAILS:**
- STAIRS AND RAMP: USE 1-1/2" SQ. X 5/32" THICK WALLED TUBING FOR POSTS AND HORIZONTAL RAILS EXCEPT THE TOP 1-1/2" ROUND HAND RAIL.
  - STANDARD HANDRAIL (W/O PICKETS) IS ALLOWED ON FINISHED PLATFORM HEIGHTS OF 30" AND LESS. ALL PLATFORM HEIGHTS ABOVE 30" SHALL USE PICKET STYLE HANDRAILS.
  - PLATFORM: USE 1-1/2" SQ. X 5/32" THICK WALLED TUBING FOR POSTS AND ALL HORIZONTAL RAILS.
  - HEIGHT: TOP OF GRIPPING SURFACES OF HANDRAILS SHALL BE 36 INCHES VERTICALLY ABOVE WALKING SURFACES.
- WELDING:**
- ALL REFERENCES TO WELDING ON PLAN SET REFER TO IN-PLANT FABRICATION. NO ON-SITE WELDING IS REQUIRED.
  - FABRICATION PLANT WELDING BY WELDERS CERTIFIED BY A THIRD PARTY INSPECTOR AND IN ACCORDANCE WITH ANSI/AWS D1.2 CODE.
  - WELD SIZES ARE EQUAL OR LARGER THAN THE ELEMENT BEING WELDED.
  - WELDING IS ALL AROUND UNLESS OTHERWISE NOTED. CARE IS TAKEN TO AVOID EXCESS WARPING OF WELDED ELEMENTS.
  - FABRICATOR TO CERTIFY ASSEMBLED PART ARE PER THE DRAWINGS PER IBC 1704.2.2.
- BOLTS:**
- ALL BOLTS SHALL BE GRADE 5 ZINC PLATED, UNLESS OTHERWISE SPECIFIED. PROVIDE LOCKING WASHERS UNDER ALL NUTS AND ANCHOR BOLTS UNLESS OTHERWISE SPECIFIED.
  - HIGH STRENGTH BOLTS ARE DESIGNED AT LESS THAN 50% CAPACITY FOR ADDITIONAL FACTOR OF SAFETY AND DO NOT REQUIRE SPECIAL INSPECTION.
- TECH. SCREWS:**
- ZINC PLATED #10x1 1/2", SELF TAPPING.

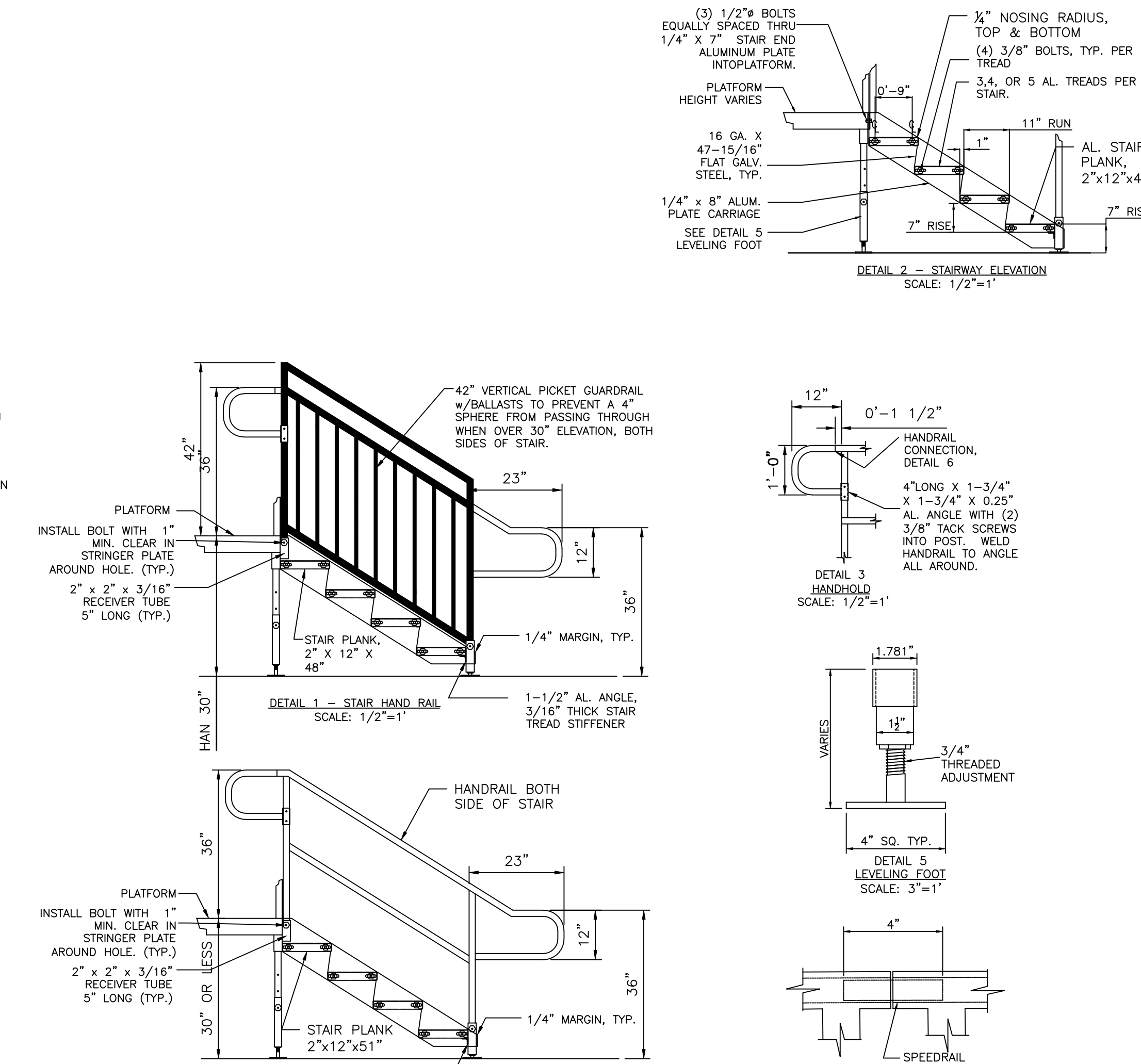
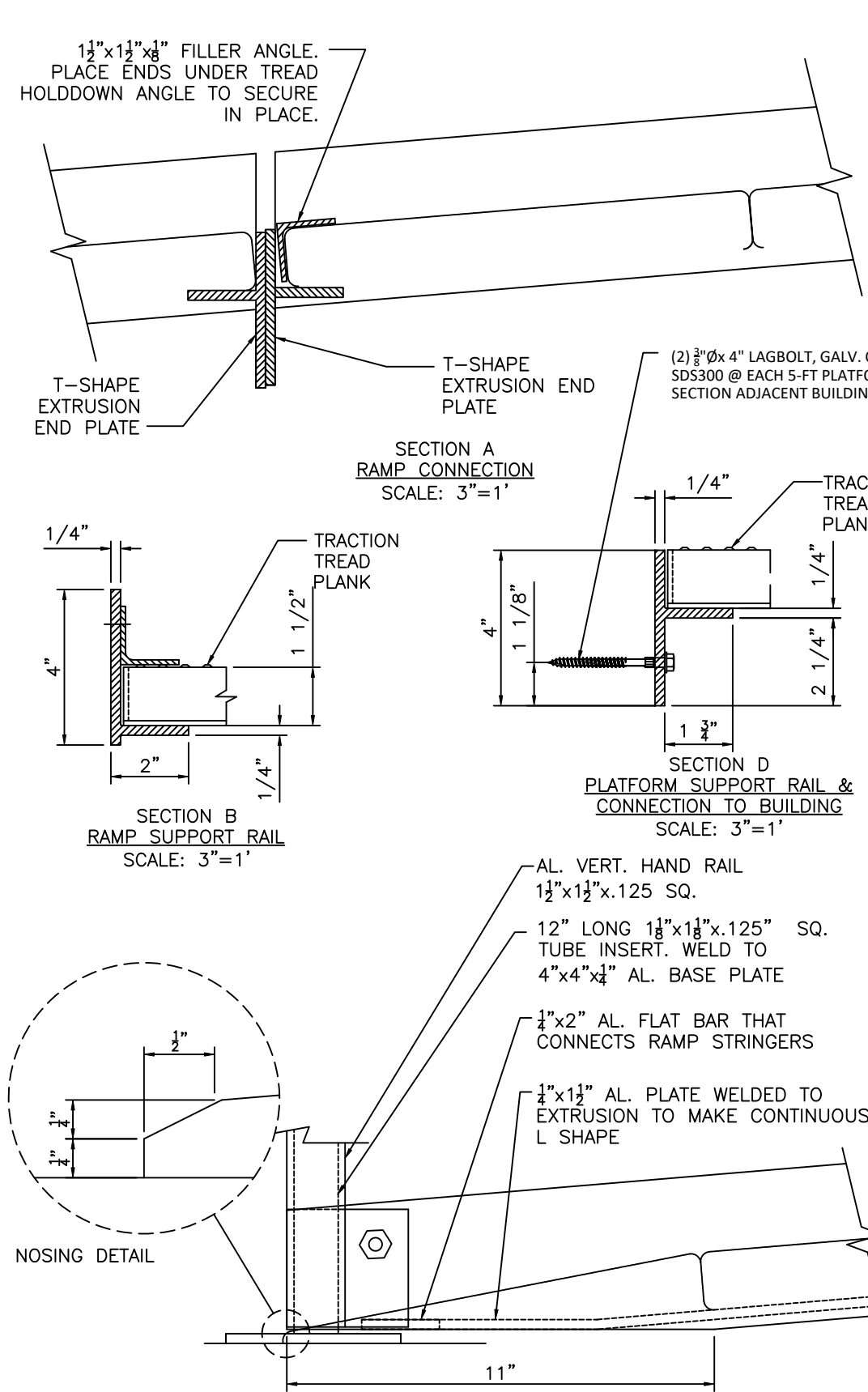
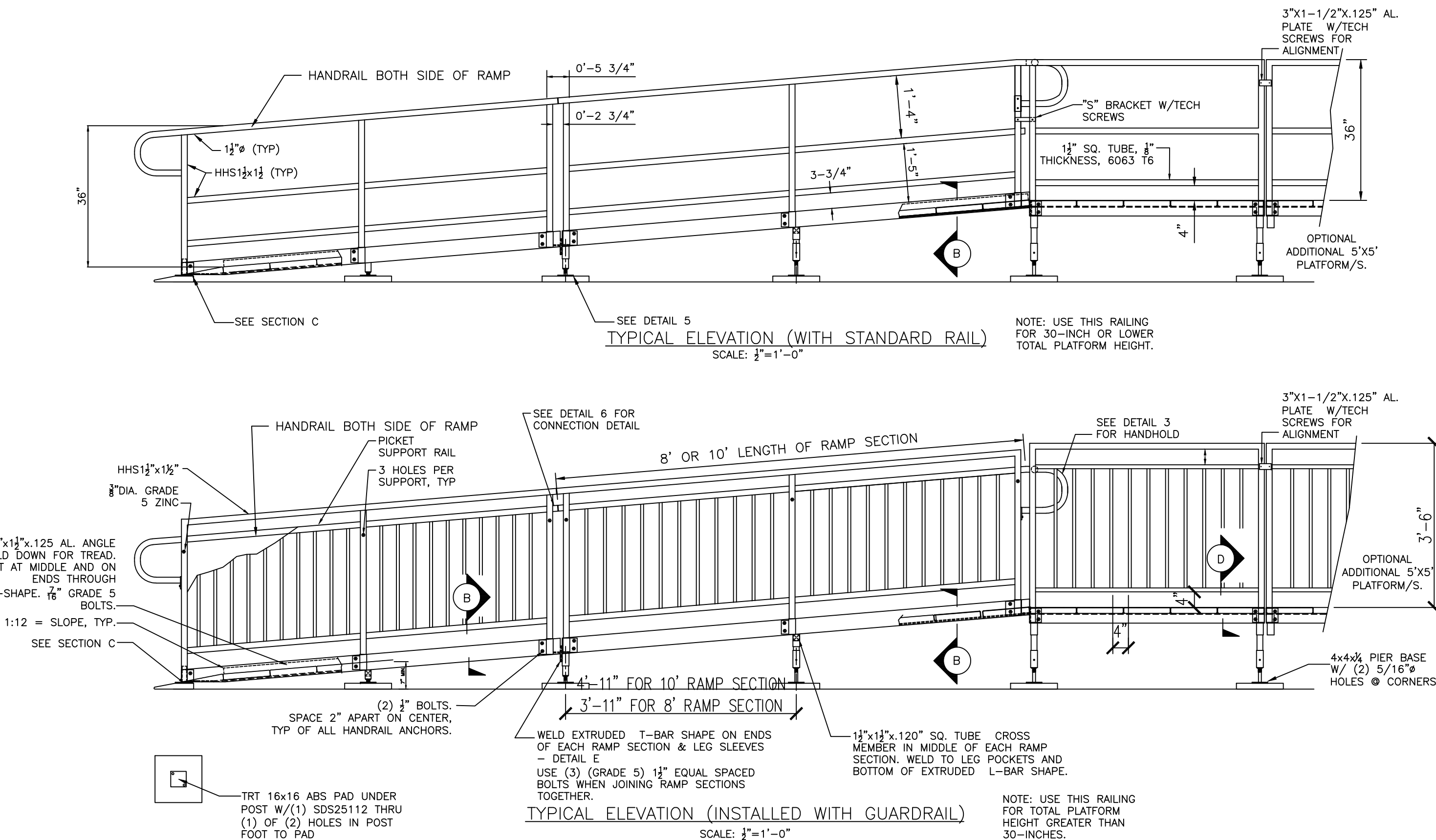

DEAN W. BRIGGS, PE  
**BRIGGS**  
 SERVING THE WESTERN UNITED STATES  
 PO BOX 140537, GARDEN CITY, ID 83714 - (208) 871-0000  
 THESE DRAWINGS OR ANY PART THEREOF SHALL NOT BE USED FOR ANY PROJECT OR EXTENSION OF THE PROJECT EXCEPT BY WRITTEN AGREEMENT FROM DEAN W. BRIGGS, PE

RENEWALS: 09/27/2021

PROJECT NAME:  
**STANDARD ACCESS PLANS  
 DECK, RAMP & STAIRS**

DATE: 01/22/2019  
 BY: DB/TG  
 SHEET 1 OF 1

WELCOME RAMP SYSTEMS, INC.  
 ACCESS RAMPS & STAIRS  
 STANDARD PLANS/DETAILS/NOTES

USE OF THESE DRAWINGS OR DESIGN FOR OTHER THAN WELCOME RAMP SYSTEMS PRODUCTS IS PROHIBITED. WELCOME RAMP SYSTEMS, INC. SHALL NOT BE RESPONSIBLE FOR THE USE OF THESE DRAWINGS OR DESIGN FOR OTHER THAN WELCOME RAMP SYSTEMS PRODUCTS. THE USE OF THESE DRAWINGS OR DESIGN FOR OTHER THAN WELCOME RAMP SYSTEMS PRODUCTS SHALL BE AT THE USER'S SOLE RISK AND WITHOUT LIABILITY TO WELCOME RAMP SYSTEMS, INC.